



profine
INTERNATIONAL PROFILE GROUP

Your comfortable sliding door system.

profine PremiLine





Smooth-running. Long-Lasting. Secure.

Comfort comes in many guises – PremiLine, the new exceptionally smooth-running profine sliding door system will introduce you to a few new ones.

Comfort has many forms. Such as opening and closing a PremiLine sliding door. Doors that run this smoothly are very easy to handle, moving freely at the slightest touch. Even for large panes of glass, the exceptionally high stability of PremiLine profiles guarantee outstandingly smooth running doors.

Due to the high static stability of the entire construction, PremiLine sliding doors also provide a high degree of security. And because PremiLine sliding doors are so long-lasting, you can sit back and enjoy increased comfort from now on, as high-quality stainless steel rails allow your PremiLine sliding doors to glide. Smoothly. Lastingly. Securely.



A great outlook made to measure.

Wide or high – PremiLine profiles also enable large-size sliding doors to be realised, allowing a beautiful view to be optimally highlighted. This really puts things into perspective!



A sliding door is an important stylistic element for your house or apartment. PremiLine profiles provide sliding doors with an attractively striking look – thanks to their slanting edges on both sides of the panes. The steel reinforcements and centre section of the PremiLine profiles, which is strengthened with a full length aluminium handle, provide effective statics that also enable large

sliding elements to be realised. For different installation conditions, there are also different pane casements available to make sure you can enjoy the maximum possible window space your dimensions can offer – both in terms of height and width. Comfort made to measure.

In addition to the various single colours, PremiLine is also available covered in wood-grained foil.

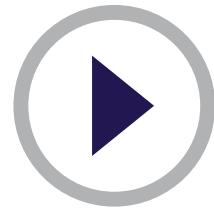

PremiLine – open for many possibilities.

Appropriate design:

Besides white, PremiLine is also available with a foil coating in different colours or wood grain patterns one or both sides.

Glazing flexibility:

When selecting the glazing, there are a whole range of options to choose from. Special glass types up to 28 mm thick can also be used.

Useful variations:

On request, a letter box can also be integrated into your PremiLine sliding door.

Real partitions:

Spartitioned sliding doors with genuine muntin bars can also be made.

A practical accessory: the integrated letterbox.



greenline 

The PremiLine system's long-lasting plastic profiles have been stabilised using environmentally friendly calcium-zinc and have an extremely low maintenance requirement. In contrast to wooden profiles, they never need painting.

A most convincing design.

Many benefits of a PremiLine sliding door are plain for all to see. Others are to be found in subtle details.

The slanting edges on both sides of the PremiLine sliding door profiles are responsible for the striking design. And these profiles are compatible with all standard 70-mm window systems. A further benefit is contained in the construction of the profile itself: the frame can be welded into place or attached mechanically on site.

When especially large sliding doors are to be installed, this feature enables the elements to be transported through narrow stairways without any difficulty.

Top quality and the perfect co-ordination of all components are the most important features. Combined with the intricate technical details of a PremiLine sliding door, all this results in an optimal overall design.



Profile corners also available with butt joints.

Rollers made of special hard PVC ensure the doors run exceptionally smoothly and easily.

Running rails of high quality stainless steel guarantee the maximum service life possible.

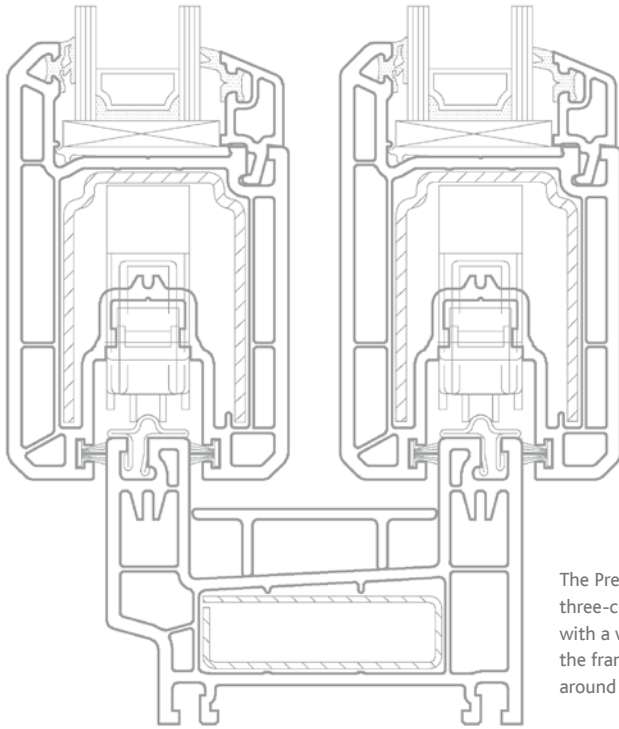

The centre section where the door frames overlap is strengthened by the full-length aluminium handle, making the system highly stable, secure and draft-free.

The PremiLine profile is a three-chamber construction with a width of 80 mm on the frame sides and 54 mm around the glass panes.

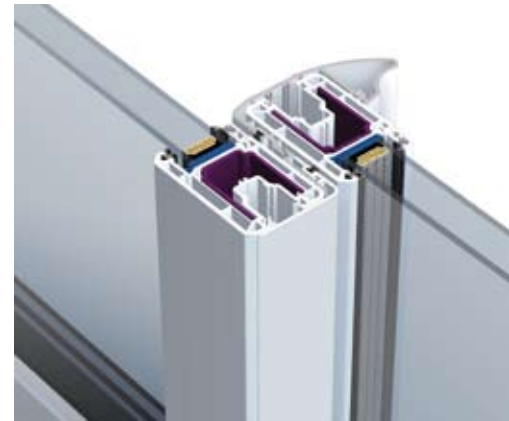

A flexible system.

When it comes to versatility, PremiLine sliding doors are at the top of the range. The system's inherent flexibility allows it to be fitted into many different kinds of opening.

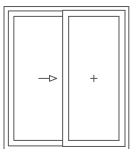

Two-part element with one sliding door and one fixed pane.

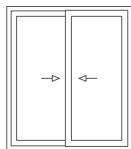

Two-part element with two sliding doors.

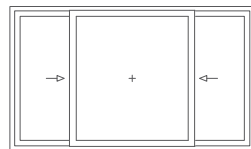

Three-part element with two sliding doors and a fixed pane in the centre.

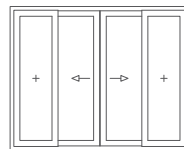

Four-part element with two sliding doors in the centre and a fixed pane on each side.

The design and structure of the PremiLine profile and its high degree of static stability offer many benefits:

- ▶ The sliding elements are outstandingly smooth-running and move at the slightest touch.
- ▶ Extremely long-lasting thanks to minimal wear.
- ▶ Profiles and frame provide a high level of security.
- ▶ Large window panes and sliding elements can also be realised.
- ▶ Striking design with a choice of seals in black or grey.
- ▶ Available in a wide range of different colours and installation variations.